

WOODSTOCK 4

MONTAGEANWEISUNG—ASSEMBLING INSTRUCTION—NOTICE DE MONTAGE—SAMLEANVISNING

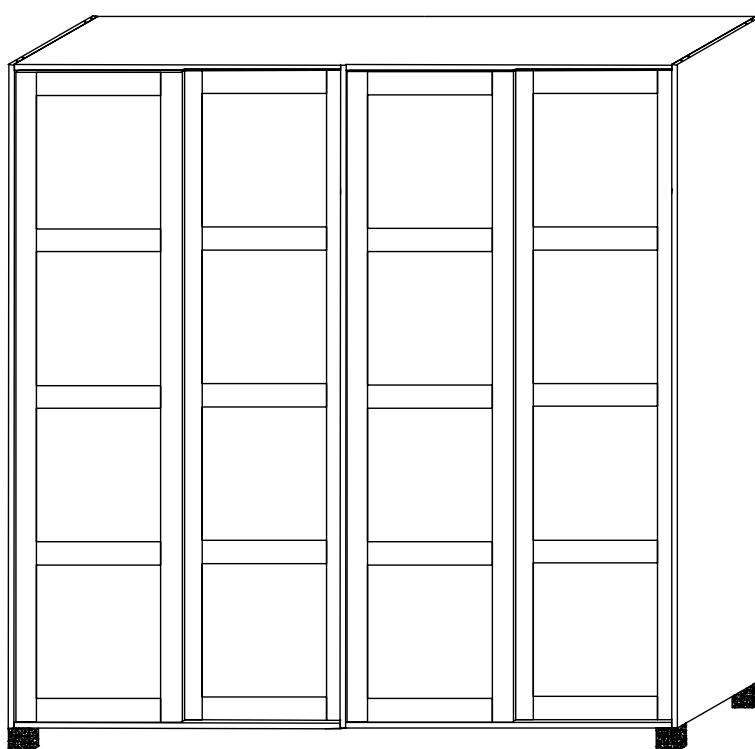

(D)

Kleiderschrank

Ref.: Woodstock 4

H 200 B 194 T 56

Kiefer massiv

ACHTUNG:

Bevor Sie mit der montage beginnen, lesen Sie bitte die Montageanleitung und überprüfen Sie den inhalt. Sortieren Sie Schrauben, Beschläge und Möbelteile der übersicht. Bei Rückfragen wenden Sie sich bitte an Ihr Möbelhaus. Montieren Sie Ihr Möbel genau nach den angegebenen Schritten der Montageanleitung.

(GB)

Wardrobe

Ref.: Woodstock 4

H 200 W 194 D 56

Solid pine

IMPORTANT:

Before assembling please read the instructions and check the contents of the package. Sort screws, fittings etc. and the model parts as listed in the special sheet. If there are any questions please contact your furnitureshop. Now assemble your furniture exactly following the instructions.

(F)

Amoire à vêtement

Ref.: Woodstock 4

H 200 P 56 L 194

Pin massif

IMPORTANT:

Bien lire la notice de montage avant commencer. Contrôlez le contenu. Triez vis et ferrures selon les instructions. Assemblez le meuble suivant l'ordre de numérotage et en vous référant aux illustrations. S'il vous manque quelque chose, téléphonez au magasin. Après quelques semaines, les vis et les brouillons pourront éventuellement être resserrés.

(DK)

Klædeskab

Ref.: Woodstock 4















H 200 B 194 D 56

Massivt fyrtræ

VIGTIG:

Læs samleanvisningen igennem inden påbegyndelse af samlingen og kontroller indholdet. Sorter beslag og møbeldele som vist på indholdsoversigten. Hvis der opstår problemer, kontakt da forhandleren. Produktet samles skridtvis, som samleanvisningen angiver.

WOODSTOCK 4

- 1 26x 8x30mm 
- 2 26x  26x
- 3 18x  18x
- 4 8x  8x
- 5 36x  3,5x15mm
- 6 2x  7x50mm
- 7 4x  4x
- 8 1x (100pcs)  1x (100pcs)
- 9 8x  8x
- 10 8x  8x
- 12 1x  1x
- 13 4x  4,0x40mm
- 14 4x  3,5x25mm
- 15 8x  8x
- 16 4x  4x

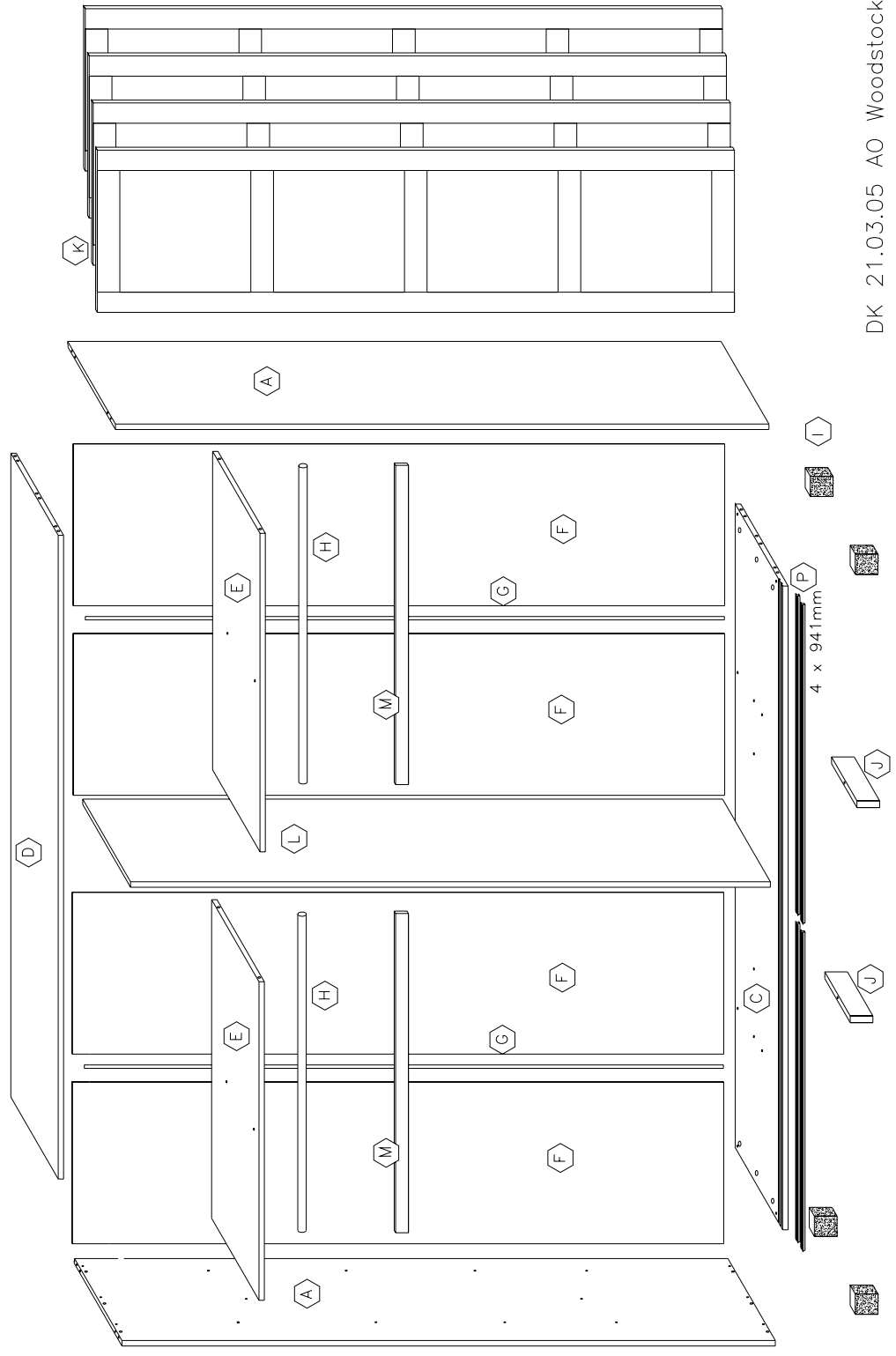
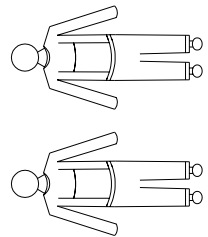

WOODSTOCK 4

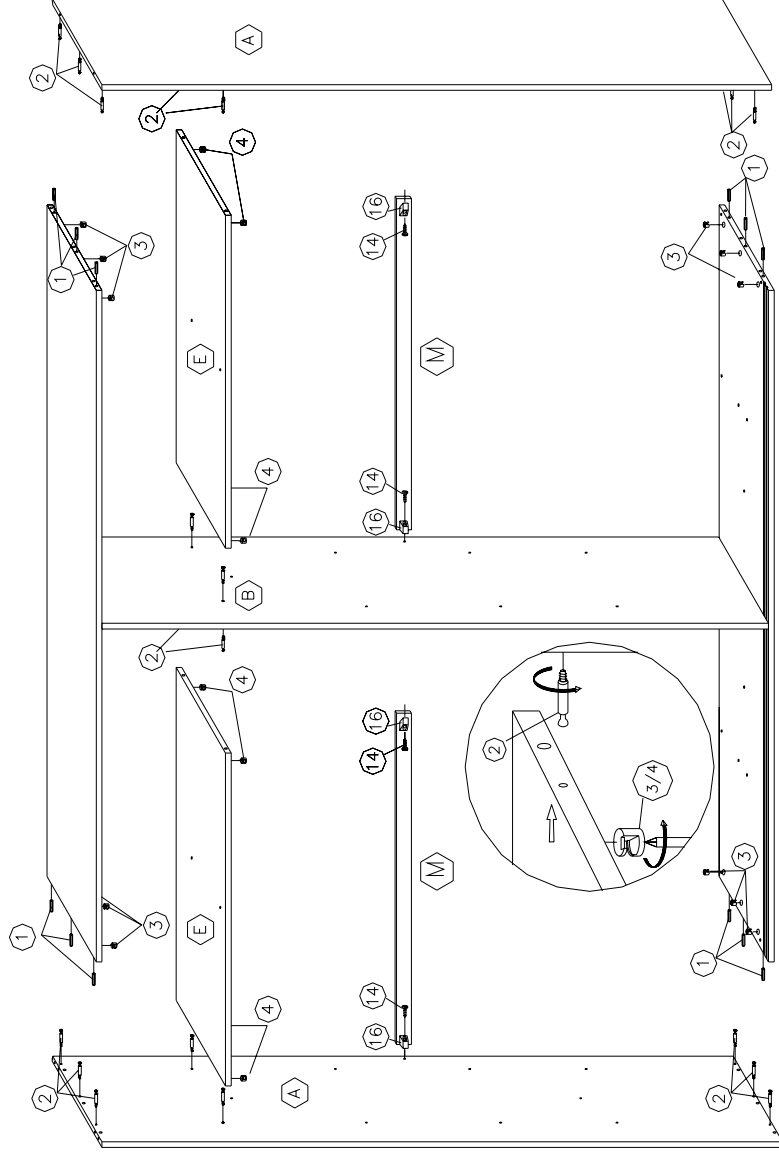
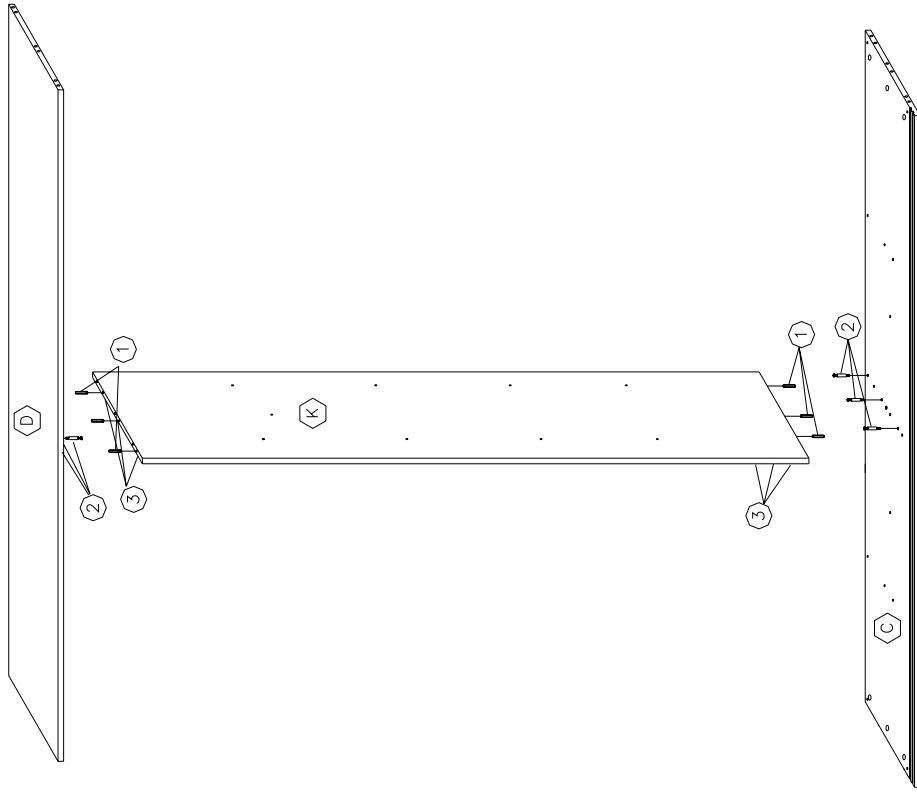

WOODSTOCK 4

4



9



10



5

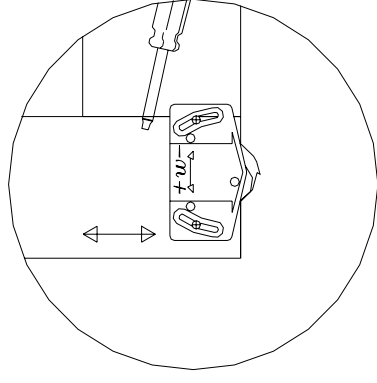
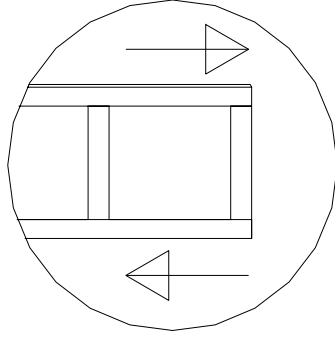
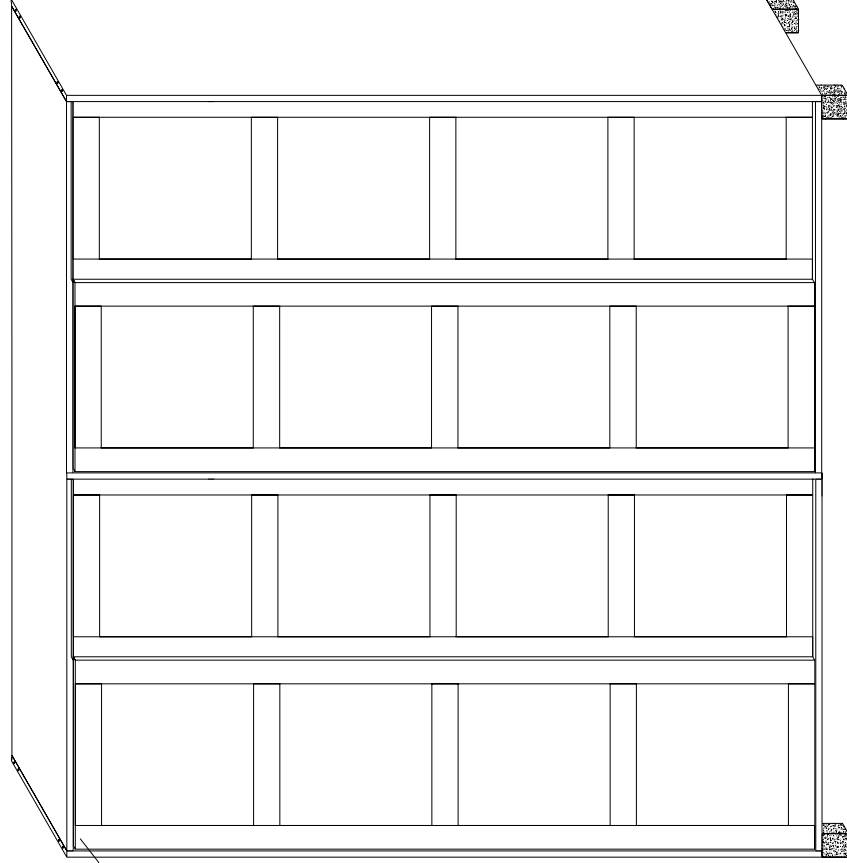
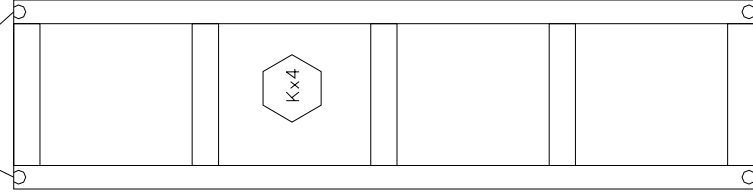
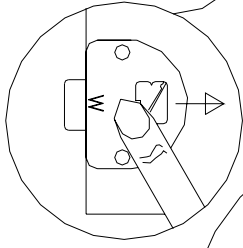
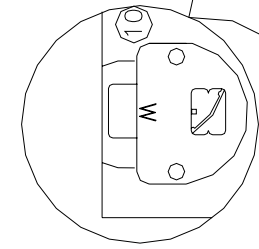

- Ⓚ TÜREN EINSTELLUNG
- ⒸⓅ ADJUSTMENT OF THE DOORS
- Ⓕ AJUSTAGE DES PORTES
- Ⓔ AJUSTE DE PUERTAS
- Ⓝ LÅGE JUSTERING